

1902363 ARM-0502

# Tablet mounting plate

<b>DAN</b>	Brugermanual	<b>LAV</b>	Lietošanas pamācība
<b>DEU</b>	Benutzerhandbuch	<b>LIT</b>	Naudojimo instrukcija
<b>ENG</b>	User manual	<b>NLD</b>	Gebruiksaanwijzing
<b>EST</b>	Kasutusjuhend	<b>NOR</b>	Brukermanual
<b>FIN</b>	Käyttöopas	<b>POL</b>	Instrukcja obsługi
<b>FRA</b>	Manuel d'utilisation	<b>SPA</b>	Manual del usuario
<b>HUN</b>	Felhasználói kézikönyv	<b>SWE</b>	Användarmanual

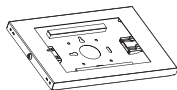
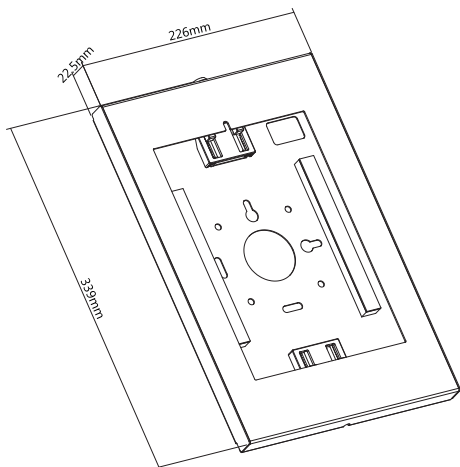

**A (x1)**

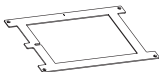

**B (x1)**

1

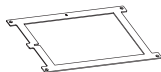

**C (x1)**

2

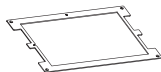

**D (x1)**

3

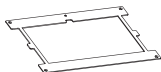

**E (x1)**

4

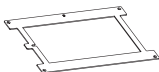

**F (x1)**

5

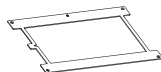

**G (x1)**

6



**H (x4)**

M4x12



**I (x4)**

ST4.8x30



**J (x4)**

Ø6x30



**K (x1)**



1

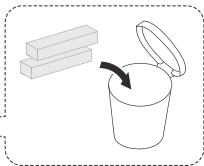
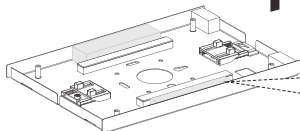
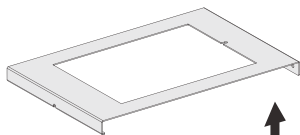
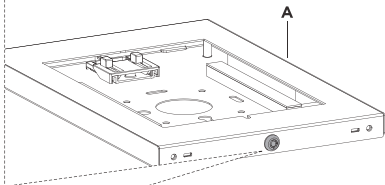
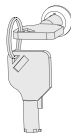

**DAN** Fjern skumstrimler før montering.

**DEU** Schaumstoffstreifen vor dem Einbau entfernen.

**ENG** Throw away the foam bars before installation.

**EST** Visake vahtplastitükid enne paigaldamist ära.

**FIN** Poista vaahтомуувyyntyt, ennen kuin asennat tuotteen.

**FRA** Enlever les bandes de mousse avant l'installation.

**HUN** Távolítsa el a habszivacs csíkokat a beszerelés előtt.

**LAV** Pirms uzstādīšanas noņemiet putuplasta sloksnes.

**LIT** Prieš montuodami, pašalinkite putplasio juosteles.

**NLD** Verwijder de schuimstrips voor installatie.

**NOR** Fjern skumlistene før montering.

**POL** Usunięcie pasków pianki przed montażem.

**SPA** Retire las tiras de espuma antes de la instalación.

**SWE** Kasta bort skumstångerna innan installation.

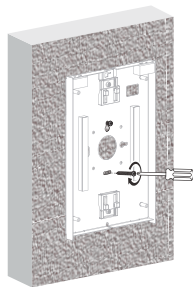
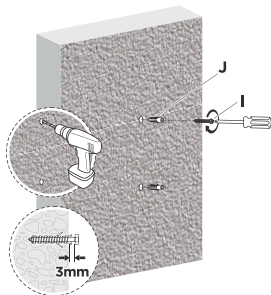
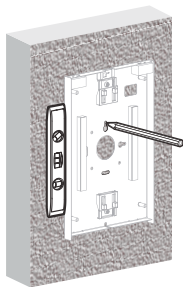
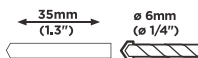
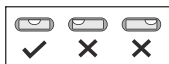
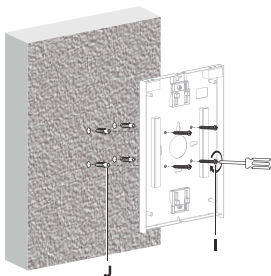
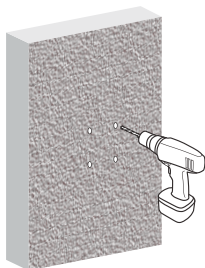
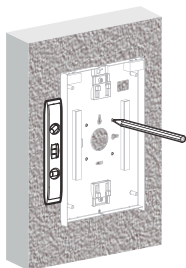
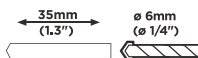
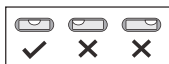
**2**

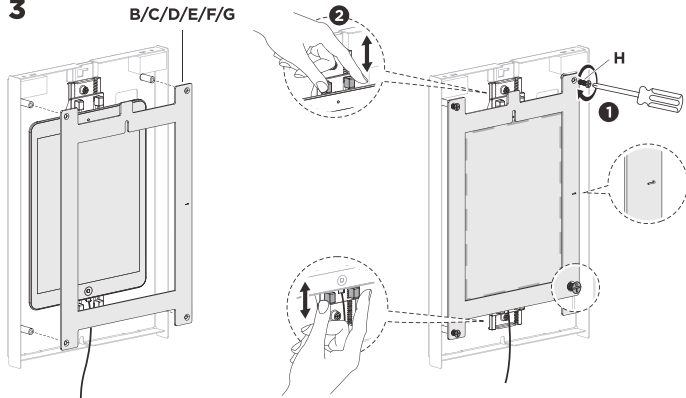
**3****B/C/D/E/F/G****DAN**

Før du strammer skrueene helt, skal du bruge afstandsstykkerne til at justere apparatets retning, så det er synligt forfra.

Dette produkt indeholder forskellige paneler, der passer til de forskellige størrelser af tablets. Vælg et matchende panel.

Panel 1: Til 9,7" iPad 5/6, iPad Air 1/2 & iPad Pro (Gen 1)

Panel 2: Til 10,2" iPad 7/8/9 & 10,5" iPad Air 3, iPad Pro (Gen 2)

Panel 3: Til 11" iPad Pro (Gen 3/4/5) & 10,9" iPad Air 4

Panel 4: Til 10,4" Samsung Galaxy Tab A7

Panel 5: Til 10,1" Samsung Galaxy Tab A

Panel 6: Til 10,4" Samsung Galaxy Tab S6 Lite

**DEU**

Bevor Sie die Schrauben fest anziehen, verwenden Sie die Abstandshalter, um das Gerät so auszurichten, dass es von vorne sichtbar ist.

Zu diesem Produkt gehören verschiedene Platten, die zu den verschiedenen Größen der Tabletten passen. Wählen Sie eine passende Platte.

Panel 1: Für 9,7" iPad 5/6, iPad Air 1/2 & iPad Pro (Gen 1)

Panel 2: Für 10,2" iPad 7/8/9 & 10,5" iPad Air 3, iPad Pro (Gen 2)

Panel 3: Für 11" iPad Pro (Gen 3/4/5) & 10,9" iPad Air 4

Panel 4: Für 10,4" Samsung Galaxy Tab A7

Panel 5: Für 10,1" Samsung Galaxy Tab A

Panel 6: Für 10,4" Samsung Galaxy Tab S6 Lite

**ENG**

Before fully tightening the screws. Use the spacers to adjust alignment and to ensure it is visible from the front.

This product includes different panels to match the different sizes of tablets. Choose a matching panel.

Panel 1: For 9.7" iPad 5/6, iPad Air 1/2 & iPad Pro (Gen 1)

Panel 2: For 10.2" iPad 7/8/9 & 10.5" iPad Air 3, iPad Pro (Gen 2)

Panel 3: For 11" iPad Pro (Gen 3/4/5) & 10.9" iPad Air 4

Panel 4: For 10.4" Samsung Galaxy Tab A7

Panel 5: For 10.1" Samsung Galaxy Tab A

Panel 6: For 10.4" Samsung Galaxy Tab S6 Lite

**EST**

Enne kruvide täielikku pingutamist kasutage vahekaitsmeid, et reguleerida joondamist ja tagada selle nähtavus eestpoolt.

See toode sisaldab erinevaid paneele, mis sobivad eri suurusega tablettidele. Valige sobiv paneel.

Paneel 1: 9,7" iPad 5/6, iPad Air 1/2 ja iPad Pro (Gen 1) jaoks

Paneel 2: 10,2" iPad 7/8/9 ja 10,5" iPad Air 3, iPad Pro (Gen 2) jaoks

Paneel 3: 11" iPad Pro (Gen 3/4/5) ja 10,9" iPad Air 4 jaoks

Paneel 4: 10,4" Samsung Galaxy Tab A7 jaoks

Paneel 5: 10,1" Samsung Galaxy Tab A jaoks

Paneel 6: 10,4" Samsung Galaxy Tab S6 Lite jaoks

## FIN

Ennen kuin kiristät ruuvit, kohdista osat paikalleen välikappaleiden avulla. Varmista, että näyttö on kunnolla näkyviissä.

Tuote sisältää eri paneeleja, jotka on tarkoitettu erikokoisille tableteille. Valitse laiteita vastaava osa.

Paneeli 1: 9,7" iPad 5/6, iPad Air 1/2 ja iPad Pro (Gen 1)

Paneeli 2: 10,2" iPad 7/8/9 & 10,5" iPad Air 3, iPad Pro (Gen 2)

Paneeli 3: 11" iPad Pro (Gen 3/4/5) ja 10,9" iPad Air 4

Paneeli 4: 10,4" Samsung Galaxy Tab A7

Paneeli 5: 10,1" Samsung Galaxy Tab A

Paneeli 6: 10,4" Samsung Galaxy Tab S6 Lite

## FRA

Avant de serrer complètement les vis, utilisez les entretoises pour ajuster l'alignement de l'appareil de manière à ce qu'il soit visible de l'avant.

Ce produit comprend différents panneaux correspondant aux différentes tailles de tablettes. Choisissez un panneau assorti.

Panneau 1 : Pour iPad 5/6 de 9,7", iPad Air 1/2 et iPad Pro (Gen 1)

Panneau 2 : Pour iPad 7 /8/9 de 10,2" et iPad Air 3 de 10,5", iPad Pro (Gen 2)

Panneau 3 : Pour iPad Pro 11" (Gen 3/4/5) et iPad Air 4 10,9

Panneau 4 : Pour Samsung Galaxy Tab A7 de 10,4"

Panneau 5 : Pour Samsung Galaxy Tab A de 10,1"

Panneau 6 : Pour Samsung Galaxy Tab S6 Lite de 10,4"

## HUN

Mielőtt teljesen meghúzná a csavarokat, a távtartók segítségével állítsa be a készülékét úgy, hogy az előlről látható legyen.

Ez a termék különböző paneleket tartalmaz a különböző méretű tablettákhoz. Válassza ki a megfelelő panelt.

Panel 1: 9,7" iPad 5/6, iPad Air 1/2 és iPad Pro (Gen 1) készülékekhez

Panel 2: 10,2" iPad 7 /8/9 és 10,5" iPad Air 3, iPad Pro (Gen 2) készülékekhez

Panel 3: 11" iPad Pro (Gen 3/4/5) és 10,9" iPad Air 4 készülékekhez

Panel 4: 10,4" Samsung Galaxy Tab A7 készülékekhez

Panel 5: 10,1" Samsung Galaxy Tab A készülékekhez

Panel 6: 10,4" Samsung Galaxy Tab S6 Lite készülékekhez

## LAV

Pirms skrūvju pilnīgas pievilksanas noregulējiet starplikas tā, lai ierīce būtu līdzena un redzama no priekšpusēs.

Izstrādājums tiek pārdots ar dažādām platformām, lai atbilstu dažādiem planšetdatora izmēriem. Izvēlieties pareizo platformu.

Platforma Nr. 1: piemērota 9,7" iPad 5/6, iPad Air 1/2 un iPad Pro (Gen 1)

Platforma Nr. 2: piemērota 10,2" iPad 7 /8/9 un 10,5" iPad Air 3, iPad Pro (Gen 2)

Platforma Nr. 3: piemērota 11" iPad Pro (Gen 3/4/5) un 10,9" iPad Air 4

Platforma Nr. 4: piemērota 10,4" Samsung Galaxy Tab A7

Platforma Nr. 5: piemērota 10,1" Samsung Galaxy Tab A

Platforma Nr. 6: piemērota 10,4" Samsung Galaxy Tab S6 Lite

## LIT

Prieš visiškai priverždami varžtus, tarpikliais sureguliuokite, kad prietaisas lygiuotų ir būtų matomas iš priekio.

Šis gaminy su parduodamas su skirtingomis platformomis, tinkančiomis įvairių dydžių planšetiniams kompiuteriams. Pasirinkite tinkamą platformą.

Platforma Nr. 1: tinkama 9,7" „iPad“ 5/6, „iPad Air“ 1/2 ir „iPad Pro“ (Gen 1)

Platforma Nr. 2: tinkama 10,2" „iPad“ 7 /8/9 ir 10,5" „iPad Air“ 3, „iPad Pro“ (Gen 2)

Platforma Nr. 3: tinkama 11" „iPad Pro“ (Gen 3/4/5) ir 10,9" „iPad Air“ 4

Platforma Nr. 4: tinkama 10,4" „Samsung Galaxy Tab“ A7

Platforma Nr. 5: tinkama 10,1" „Samsung Galaxy Tab“ A

Platforma Nr. 6: tinkama 10,4" „Samsung Galaxy Tab“ S6 Lite

## NLD

Voordat u de schroeven volledig vastdraait, gebruikt u de afstandsringen om de uitlijning van het apparaat aan te passen zodat het vanaf de voorkant zichtbaar is.

Dit product bevat verschillende panelen die passen bij de verschillende maten tablets. Kies een passend paneel.

Paneel 1: Voor 9,7" iPad 5/6, iPad Air 1/2 en iPad Pro (Gen 1)

Paneel 2: Voor 10,2" iPad 7 /8/9 en 10,5" iPad Air 3, iPad Pro (Gen 2)

Paneel 3: Voor 11" iPad Pro (Gen 3/4/5) en 10,9" iPad Air 4

Paneel 4: Voor 10,4" Samsung Galaxy Tab A7

Paneel 5: Voor 10,1" Samsung Galaxy Tab A

Paneel 6: Voor 10,4" Samsung Galaxy Tab S6 Lite

## NOR

Før du strammer skruene helt til, bruker du avstandsstykkene til å justere apparatets innretning slik at det er synlig forfra.

Dette produktet inneholder forskjellige paneler som passer til ulike størrelser av nettbrett. Velg et matchende panel.

Panel 1: For 9,7" iPad 5/6, iPad Air 1/2 og iPad Pro (Gen 1)

Panel 2: For 10,2" iPad 7/8/9 og 10,5" iPad Air 3, iPad Pro (Gen 2)

Panel 3: For 11" iPad Pro (Gen 3/4/5) og 10,9" iPad Air 4

Panel 4: For 10,4-tommers Samsung Galaxy Tab A7

Panel 5: For 10,1-tommers Samsung Galaxy Tab A

Panel 6: For 10,4-tommers Samsung Galaxy Tab S6 Lite

## POL

Przed całkowitym dokręceniem śrub użyj elementów dystansowych, aby wyregulować ustawienie urządzenia tak, aby było widoczne z przodu.

Ten produkt zawiera różne panele pasujące do różnych rozmiarów tabletek. Wybierz pasujący panel.

Panel 1: dla iPada 5/6, iPada Air 1/2 i iPada Pro (Gen 1) 9,7"

Panel 2: dla iPada 7/8/9 i iPada Air 3, iPada Pro (Gen 2) 10,2"

Panel 3: dla iPada Pro 11" (Gen 3/4/5) i iPada Air 4 10,9"

Panel 4: Dla 10,4" Samsunga Galaxy Tab A7

Panel 5: Dla 10,1" Samsunga Galaxy Tab A

Panel 6: Dla 10,4" Samsunga Galaxy Tab S6 Lite

## FIN

Antes de apretar completamente los tornillos, utilice los espaciadores para ajustar la alineación del aparato de modo que sea visible desde la parte delantera.

Este producto incluye diferentes paneles para adaptarse a los distintos tamaños de tabletas. Elija un panel adecuado.

Panel 1: Para iPad 5/6 de 9,7", iPad Air 1/2 y iPad Pro (Gen 1)

Panel 2: Para iPad 7 /8/9 de 10,2" y iPad Air 3 de 10,5", iPad Pro (Gen 2)

Panel 3: Para iPad Pro de 11" (Gen 3/4/5) y iPad Air 4 de 10,9"

Panel 4: Para Samsung Galaxy Tab A7 de 10,4"

Panel 5: Para Samsung Galaxy Tab A de 10,1"

Panel 6: Para Samsung Galaxy Tab S6 Lite de 10,4"

## SWE

Innan du skruvar fast skruvarna helt. Använd distanserna för att justera linjering och säkerställ att den är synlig från framsidan.

Denna produkt innehåller olika paneler för att matcha de olika storlekarna på surfplattor. Välj en matchande panel.

Panel 1: För 9,7" iPad 5/6, iPad Air 1/2 och iPad Pro (Gen 1)

Panel 2: För 10,2" iPad 7/8/9 & 10,5" iPad Air 3, iPad Pro (Gen 2)

Panel 3: För 11" iPad Pro (Gen 3/4/5) och 10,9" iPad Air 4

Panel 4: För 10,4" Samsung Galaxy Tab A7

Panel 5: För 10,1" Samsung Galaxy Tab A

Panel 6: För 10,4" Samsung Galaxy Tab S6 Lite

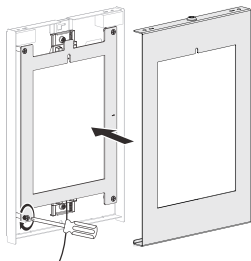

# 4

